

canning conveyor cannoflex conveyor belting

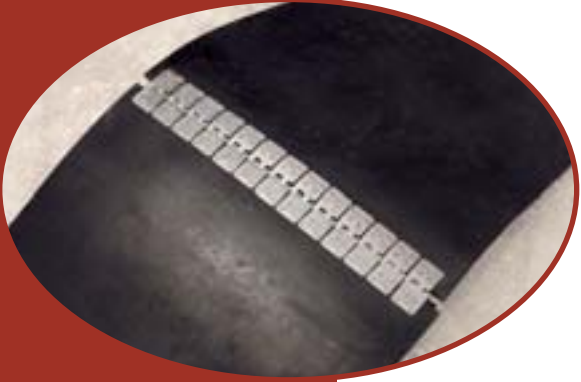

Canning Conveyor



Canning Conveyor Co. Ltd. was founded in September 1965 and in the early days its main activity was trading in conveyor belting.

Its original employees worked in a field, in the open air, and in all kinds of weather. But even in such arduous and basic conditions the customers requirements were fulfilled, and the hard lessons learned were good grounding for future years of successful trading.

Over three decades of development now see the company located in a fine complex of industrial buildings and offices.

Years of experience supplying the mining, quarrying, mechanical and civil engineering, fishing, farming, and film making industries, have made Cannings a leading name throughout the world.

Our trade is divided up as such - one third to direct users in the UK, one third to other retail outlets and vulcanising companies in the UK, and one third export.

Whether the demand is for a simple belt fastener or a mile long belt conveyor - from a single roller to the design, manufacture and installation of a complete handling plant, Cannings are able to supply with excellent professional efficiency.



Contents

Page	
1	A little about the company
2	Contents
3	Standard Belting
4	Standard Belting
5	Heat and Oil Resistant Belting
6	Grip-Face and Picking Belts
7	Chevron Belting
8	Chevron Belting
9	Chevron Belting
10	Other Products and Services

Canning Conveyor



Putting Our Customers First... ...For over three decades...

Since our foundation in 1985, our family firm has been committed to a simple philosophy: to supply the best possible equipment, with the best possible service, at the fairest price.

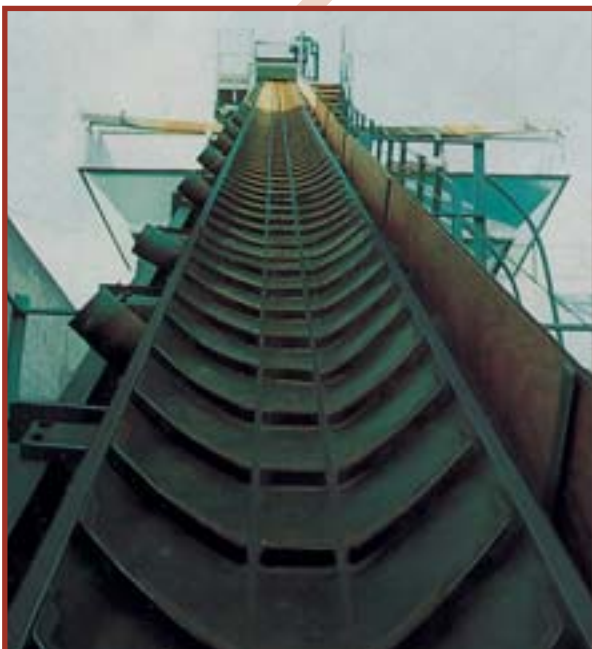

Our policy on Conveyor Belting is to supply the end user with the highest possible grade of belting at the lowest possible price, with an off the shelf and express delivery service.

With this firmly in mind we have conveyor belting manufactured specifically for Canning Conveyor under our brand name 'Cannoflex' (which is the registered trade mark for Canning Conveyor belting).

All our belts are covered with the manufacturers guarantee which is supported by Canning Conveyors reputation.

Cannoflex Standard Conveyor Belting



cannoflex® qualities

Cannoflex Standard Conveyor Belting is made with E.P. fabric plies. The top and bottom are provided with abrasion resistant rubber covers to DIN 22102 and B.S. 490.

E.P. Polyester/Polyamide (Nylon) fabric is constructed with synthetic woven fabric, utilising a Polyester fibre for warp and Polyamide fibre for weft.

Application

For conveying heavy and sharp edged goods in bulk such as gravel, crushed stone, limestone, iron pellets, glass and coal, also sand, fertilisers, etc.

Cannoflex conveyor belts are quality products with an extremely high degree of reliability. The manufacturers have over 60 years of experience in belt production.

Extensive testing devices ensure that Cannoflex belts are released only if they are first class from the viewpoint of chemical, technological, structural and manufacturing techniques.



the main feature of Cannoflex belts are:

- Low Stretch
- Excellent troughability
- High abrasion resistant covers
- Impervious to humidity and wetness
- Mildew and rot free
- High tear resistance

All Cannoflex belts carry a full one year manufacturers guarantee

Cannoflex Standard Belting technical data

TYPE	THICKNESS	WEIGHT	MINIMUM DRUM DIAMETER			MAX WORKING TENSION
RATING	O/A (MM)	KG/M2	DRIVE (MM)	TAIL (MM)	SNUB (MM)	KN/M/WIDTH
EP200/2 2+1	5.5	6.2	250	200	200	20
EP250/2 2+1	5.5	6.2	250	250	200	25
EP315/2 3+1.5	7.0	8.0	315	250	200	31
EP315/3 3+1.5	8.0	8.6	315	315	250	31
EP400/3 3+1.5	8.0	8.6	350	315	250	40
EP400/3 4+2	9.5	12.0	400	315	250	40
EP500/3 3+1.5	8.0	8.6	350	315	315	50
EP500/3 5+1.5	10.0	12.5	400	315	315	50
EP630/4 5+1.5	12.5	15.0	500	400	315	63
EP630/4 6+2	13.5	16.5	500	500	400	70
EP800/4 6+2	13.7	17.0	500	500	400	90
EP800/5 6+2	14.3	18.0	630	500	400	90
EP1000/4 6+2	14.5	18.0	630	500	400	110
EP1000/5 6+2	15.5	19.5	630	630	500	110
EP1250/4 6+2	16.0	21.0	800	630	500	140
EP1250/5 6+2	16.5	22.0	800	630	500	140
EP1600/5 6+2	17.0	23.0	1000	800	630	180

Joining

a Hot vulcanised bias stepped joint.

This method is always to be preferred. Instructions for vulcanising are available upon request.

b Cold vulcanised bias stepped joint.

Cold jointing is acceptable when the belt is exposed to normal temperatures and where the humidity and the belt tension are not too excessive.

c Belt fasteners.

Using belt fasteners is a very easy method for quick jointing of the belt. In general, the tensile strength is reduced to a much greater extent compared with a hot vulcanised belt.

Antistatic

according to DIN 22102 and BS490.

Resistant

to low concentrations of (non-oxidising) acids, bases, salts, alcohols, glycolates and acetone.

Limited resistance

to oxidising, concentrated and strong acids, oil and greases, aliphatic, aromatic and chlorinated carbonides, ketones (except acetone, to which Cannoflex has a good resistance). For carrying oily materials use Cannoflex C.O.R. oil resistant belting.

Resistant to temperatures

within a range from -30°C up to +80°C. For short periods the belt may be subjected to temperatures up to 95°C. In some circumstances, and depending upon the ambient temperature and size of the material, the temperature of the product may exceed the stated range up to approximately 120°C. For carrying material with a temperature at over 120°C use Cannoflex C.H.R. heat resistant belting.

Specialities

The topside of the belt can be fitted with carriers, corrugated sidewalls and/or spillages. Elongated at working tension (%), is 1.0-1.5%.



Cannoflex Heat Resistant Belting

CHR-100	Temperature range of material	less than 200°C
	Temperature range of belt surface	80°C – 100°C
	Cover rubber	SBR

Features CHR-100 grade has a premium quality SBR rubber compound with a very good abrasion and heat resistance to handle hot materials up to 200°C. This grade of belting is highly resistant to a variety of heat applications and gives good service for iron ore pellets, sand castings, coke, limestone, etc.

CHR-150	Temperature range of material	150°C – 350°C
	Temperature range of belt surface	100°C – 150°C
	Cover rubber	EPDM

Features CHR-150 grade has a hot belt compound of ethylene propylene rubber giving excellent heat resistance designed to carry hot materials without cracking. This grade of belting is most suitable for powdery materials such as cement products, fine limestone, clay, slag, steel millings, etc.

CHR-200	Temperature range of material	150°C – 450°C
	Temperature range of belt surface	120°C – 180°C
	Cover rubber	EPR

Features CHR-200 grade is the highest quality conveyor belting available for maximum heat resistance. This grade of belting is specially formulated EPR (ethylene propylene rubber) which provides superior heat resistance and ply adhesion for carrying hot cement clinker, phosphate, hot sintered ore and hot chemical fertilisers, etc.

Cannoflex Oil Resistant Belting

COR - 100	Temperature range of material	-25°C – +60°C
------------------	-------------------------------	---------------

Features A moderately oil resistant compound designed for applications where some oily chemical conditions are found.

Types of oil Mineral, heavy oil, Barbolin rust preventative oil, light oil, neuter oil, rolling oil, grease, machine oil, drain sewage, etc.

COR - 200	Temperature range of material	-25°C – +60°C
------------------	-------------------------------	---------------

Features A grain and vegetable oil resistant compound that is also electrically conductive to dissipate static electricity.

Types of oil Animal oil, vegetable oil, palm oil, lard, fish oil, soya bean oil, sesame oil, cotton oil, rice oil, frying oil, catering oil, dust, excreta, sewage, etc.

Cannoflex Grip-Face Belting

CGF	Construction	EP200/2 – EP315/3
	Colours	Black or Green
	Maximum Width	1800mm
	Thickness	6mm – 8mm

Application Designed for carrying light weight goods either inclined or horizontally. Ideal for papers, bags, boxes, cartons, etc.

Features The rough mesh pattern moulded into the top cover, has good cushioning properties and absorbs impacts and vibrations during transportation and simultaneously prevents slipping. There is a choice of friction or a rubber covered back surface.

Cannoflex Smooth-Face Picking Belts

CSF	Construction	EP200/2 – EP315/3
	Maximum Width	2150mm
	Thickness	4mm – 8mm
	Top Rubber Cover	2mm – 4mm

Application Designed for transportation of lightweight materials at slight inclines or horizontally. Ideal for carrying automotive, engineering and machined components, etc.

Features The smooth surface has good cushioning properties, with the advantage of convenient picking and for the use of cleaning devices if required. There is a choice of friction or a rubber covered back surface.

Cannoflex Special Belting

We also supply other special belts to order.

- **Elevator**
- **Steel cord**
- **Solid woven**
- **Cleated**
- **Food quality**
- **P.V.C.**
- **Flame resistance**
- **High wall**
- **And many more...**

Please contact our sales office for a competitive quotation and advice.

Cannoflex Chevron Conveyor Belting C15

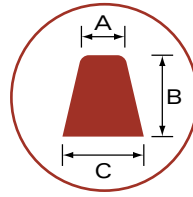
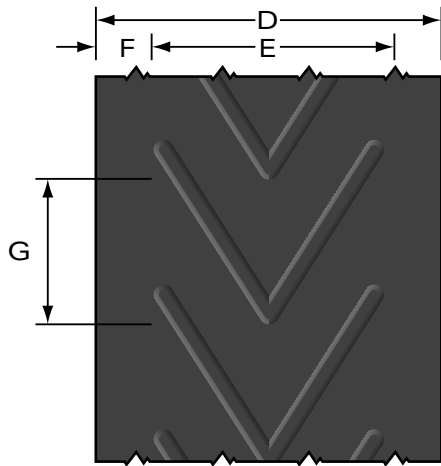

A	8 MM
B	15 MM
C	15 MM

C15 - 330

BELT WIDTH D MM	PATTERN WIDTH E MM	MARGIN F MM	PITCH G MM
400	330	35	250
450	330	60	250
500	330	85	250
600	330	135	250

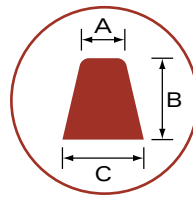
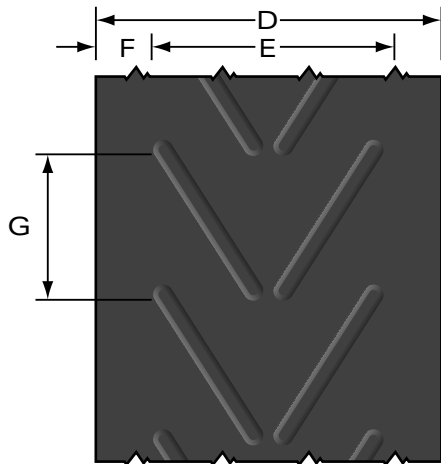

A	12 MM
B	15 MM
C	15 MM

C15 - 385

BELT WIDTH D MM	PATTERN WIDTH E MM	MARGIN F MM	PITCH G MM
450	385	32	250
500	385	58	250
600	385	108	250
650	385	133	250
750	385	183	250

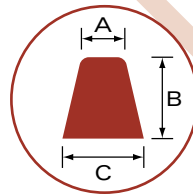
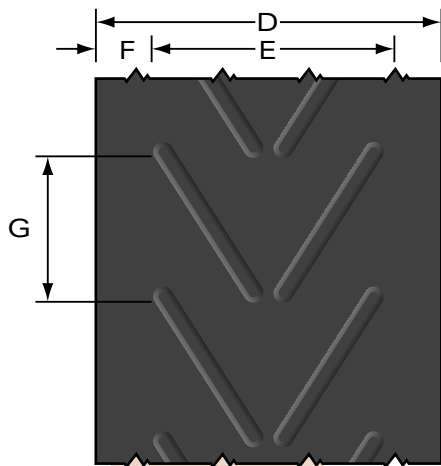

A	12 MM
B	15 MM
C	15 MM

C15 - 450

BELT WIDTH D MM	PATTERN WIDTH E MM	MARGIN F MM	PITCH G MM
600	450	75	300
650	450	100	300
750	450	150	300
800	450	175	300
900	450	225	300

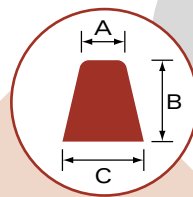
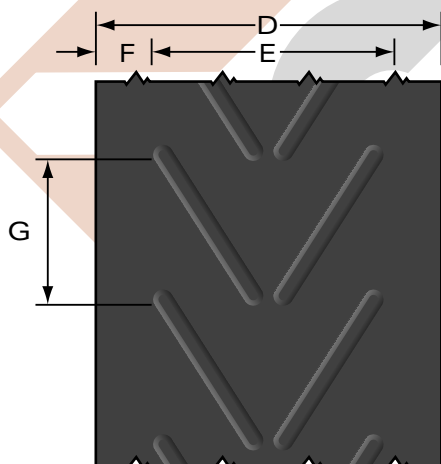

A	12 MM
B	15 MM
C	15 MM

C15 - 750

BELT WIDTH D MM	PATTERN WIDTH E MM	MARGIN F MM	PITCH G MM
900	750	75	250
1000	750	125	250
1050	750	150	250
1200	750	225	250

Cannoflex Chevron Conveyor Belting C25

C25 - 450

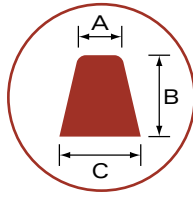
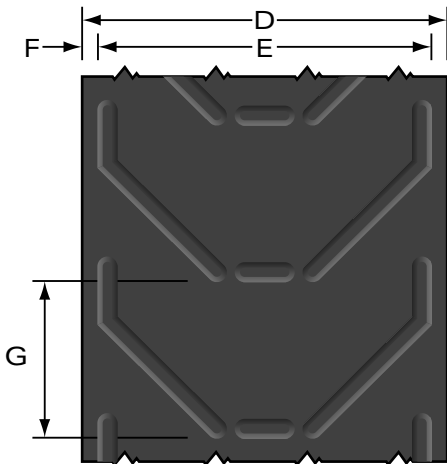

A	12 MM
B	25 MM
C	25 MM

BELT WIDTH D MM	PATTERN WIDTH E MM	MARGIN F MM	PITCH G MM
500	450	25	335
600	450	75	335
650	450	100	335
750	450	150	335

C25 - 550

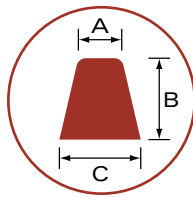
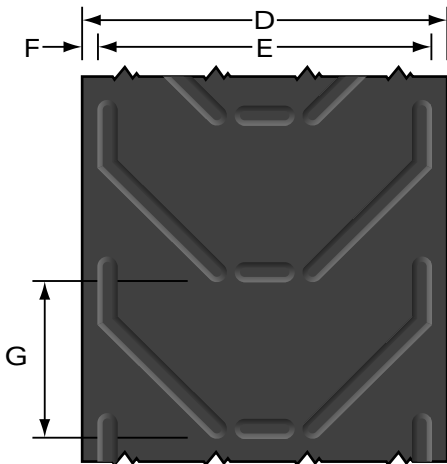

A	12 MM
B	25 MM
C	25 MM

BELT WIDTH D MM	PATTERN WIDTH E MM	MARGIN F MM	PITCH G MM
650	550	50	250
750	550	100	250
800	550	125	250
900	550	175	250
1000	550	225	250

C25 - 750

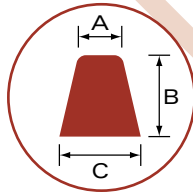
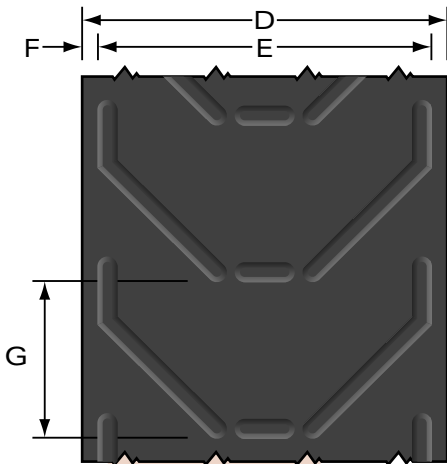

A	12 MM
B	25 MM
C	25 MM

BELT WIDTH D MM	PATTERN WIDTH E MM	MARGIN F MM	PITCH G MM
900	750	75	330
1000	750	125	330
1050	750	150	330
1200	750	225	330

These three pages illustrate our present range of chevron belting. We offer a full range of sizes with a variety of pattern types, to suit most applications. All Cannoflex chevron belts have the advantage of integrally moulded as part of the top surface, during the manufacturing process.

All belts are suitable for jointing by vulcanising or by mechanical belt fasteners.

All belts are ex-stock

Cannoflex Chevron Conveyor Belting C32

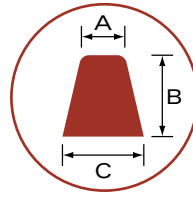
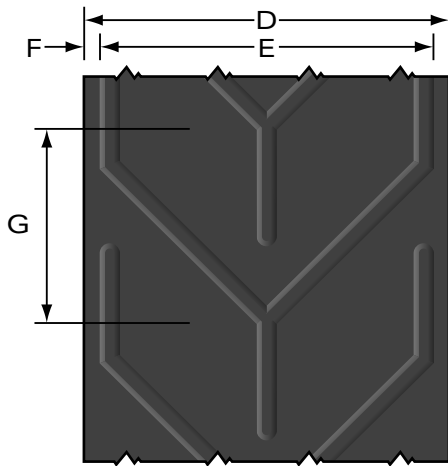

A	12 MM
B	32 MM
C	25 MM

C32 - 600

BELT WIDTH D MM	PATTERN WIDTH E MM	MARGIN F MM	PITCH G MM
750	600	75	300
800	600	100	300
900	600	150	300
1000	600	200	300
1050	600	225	300

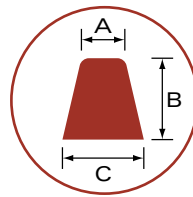
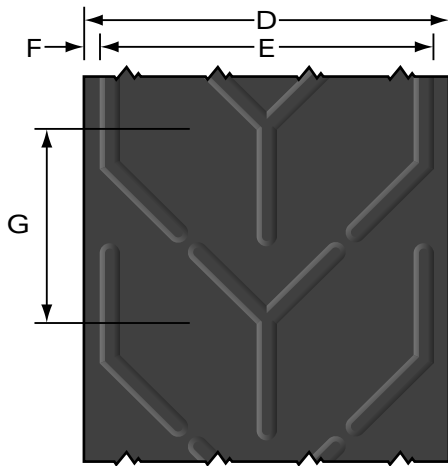

A	16 MM
B	32 MM
C	32 MM

C32 - 800

BELT WIDTH D MM	PATTERN WIDTH E MM	MARGIN F MM	PITCH G MM
900	800	50	333
1000	800	100	333
1050	800	125	333
1200	800	200	333

Cannoflex Chevron Conveyor Belting technical data

TYPE	RATING		WEIGHT	MINIMUM DRUM DIAMETER		
			KG/M2	HEAD (MM)	TAIL (MM)	SNUB (MM)
C15	EP200/2	3+2	8.8	200	200	200
	EP250/2	3+2	8.9	250	200	200
	EP315/3	3+2	9.2	250	250	200
C25	EP315/3	3+2	14.0	315	250	200
	EP400/3	3+2	14.2	315	250	250
	EP400/3	4+2	16.0	315	315	250
	EP500/3	4+2	18.0	400	315	250
	EP500/3	5+1.5	19.0	400	315	250
	EP630/4	5+1.5	22.5	500	400	315
C32	EP400/3	4+2	18.1	400	315	315
	EP500/3	4+2	19.4	500	400	315
	EP500/3	5+1.5	21.6	500	400	315
	EP630/4	5+1.5	25.2	500	400	315



◀ Cannoflex Chevron Conveyor Belting C25-550

Other products and services

Belt Fasteners A full complement of belt clips, fasteners and tools are available ex. stock.

- | | |
|---------------|-----------------------|
| ■ Flexco | ■ MRE |
| ■ Jackson | ■ Masterbar |
| ■ Hydon Nylos | ■ Tools & Accessories |

Vulcanising We offer a 24hour, nationwide belt vulcanising and belt fitting service. Fully experienced teams, using the latest equipment are available for on site or in-house endless vulcanising.

Delivery Service Our delivery service covers the whole of the British Isles, offering a guaranteed 'next day' or '3 day' service. We export throughout the world at very competitive rates.

Belt Reeling We manufacture a range of portable belt reeling machines, with choice of diesel or electric drives. These machines are for sale or hire. We also offer our service of experienced operatives to roll up your belts.

Other Products Rubber flooring for factories, workshops, etc., skirt rubbers, chute rubber/linings, deep sea fishing and farming accessories, rubber doors, mats, etc.

Second hand conveyor belting

For a quarter of a century Cannings have been supplying second hand Conveyor Belting to the Mining and Quarrying industries.

Our customers range from the large multi-national mining and quarrying organisations to ready-mixed concrete plants, stone, sand and gravel quarries, mines, screening and crushing operations, shipping wharfs, warehouses and the farming industry. We also export large amounts of belting to our agents and customers throughout the world.

No other company has the facilities and expertise to handle the amount of belting which our company supplies.

All second hand belts are thoroughly examined by our expert staff - only belts which are sound in strength and show very little wear are supplied as reusable. Belts which do not pass examination are used for making other products.

Our sales staff take pride in their fast, friendly service and have at their fingertips the latest stock position and prices.



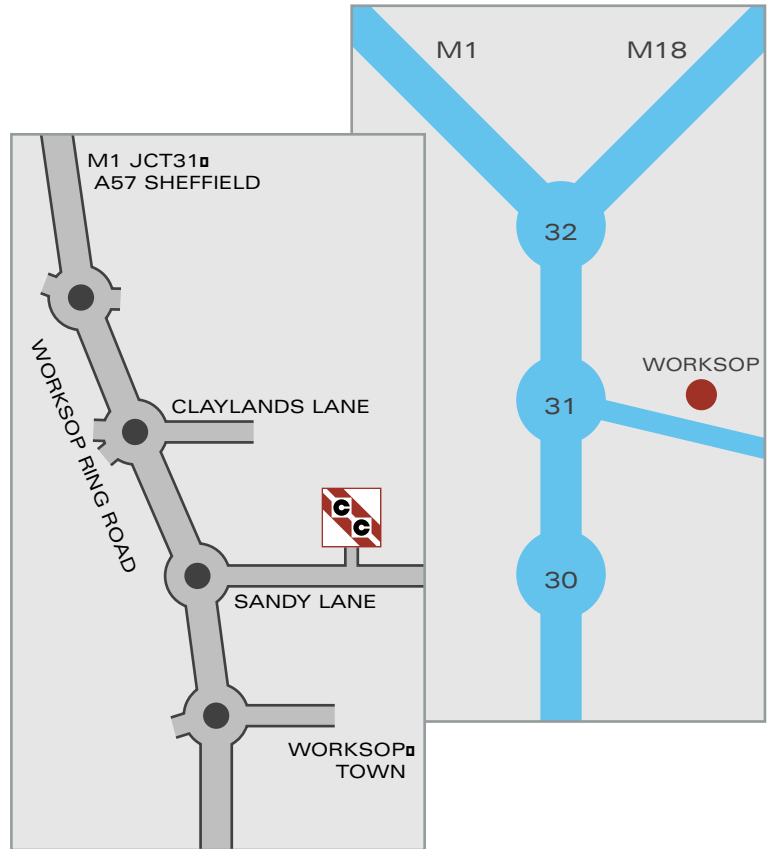
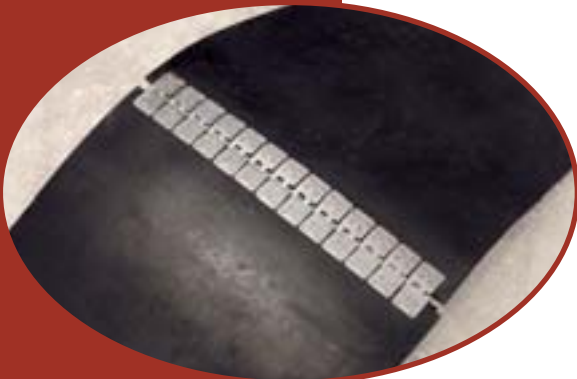

Canning Conveyor

Canning Conveyor Co. Ltd.
 Sandy Lane Industrial Estate
 Worksop
 Nottinghamshire S80 1TN
 Telephone 01909 486166
 Facsimile 01909 500638

Cannoflex Standard Belting

Cannoflex Chevron Belting

Cannoflex Oil & Heat Resistant Belting

Second Hand Belting

CMS Conveyor System

Mobile Conveyors

Feeders & Hoppers

Conveyor Systems

Drive Units

Bearings

Film & TV Construction

Deep Sea Fishing Products

Conveyor Belt Fasteners

Vulcanising

Belt Reeling Machines

Troughing Idlers

Return Rollers

Suspended Idlers

Replacement Rollers

Conveyor Drums

Gearboxes

Farming Conveyors

Rubber Farming Products

Ancillary Products

The information contained in this booklet is approximate only, not binding in anyway and subject to alterations without notice.